

deli

USER MANUAL

RECEIPT PRINTER

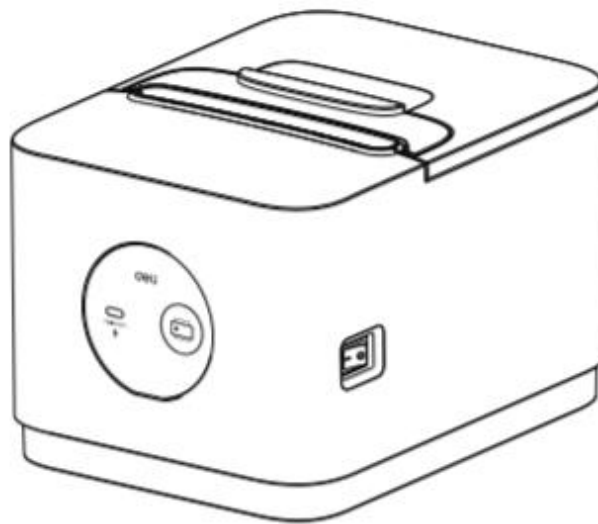

S380P、S380PN

1.Packing List

Please check if the product is intact after unpacking and verify that all the accessories have been received. If any items are missing, please contact your dealer.



Printer



USB cable



User manual



Power adapter

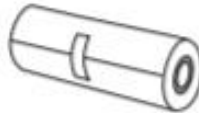

Paper roll

Warm tip: Please use the supplied CD or go to dell official website
<http://www.dell.com/> to download the driver.

Note: The symbol means that this product is safe for use in non-tropical climates only.

2.Appearance and Components

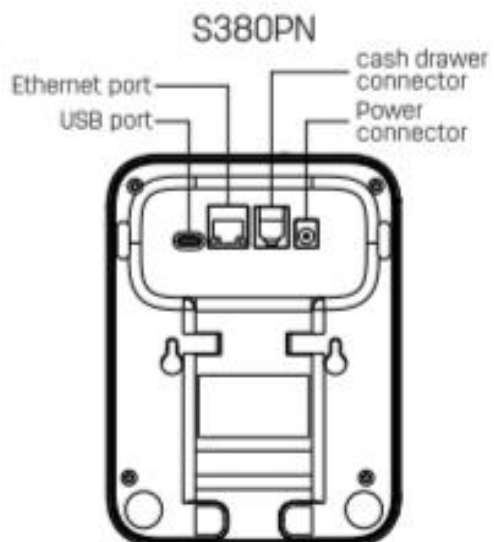
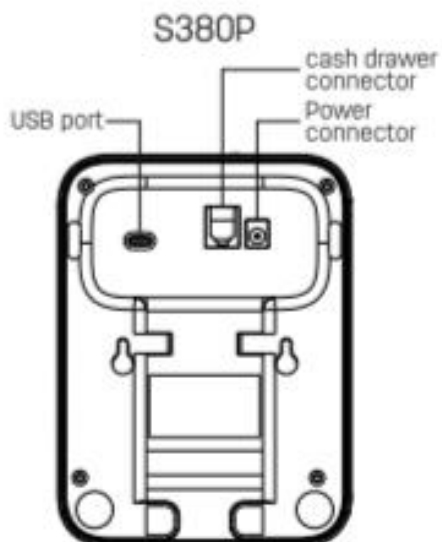
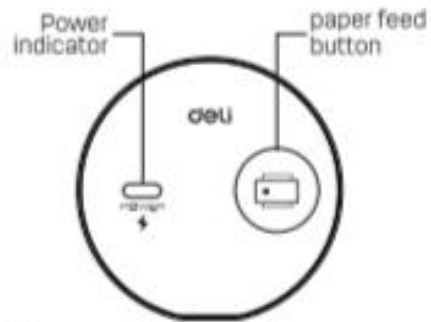
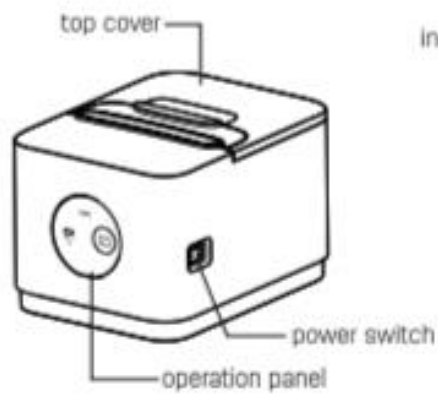

3.Loading the paper roll

- 1.Face the front of the printer, upward the top cover button in the direction of the arrow, and lift the top cover up. (The arrow diagram is shown below).
- 2.If there is a paper roll in the paper compartment, please take it out.

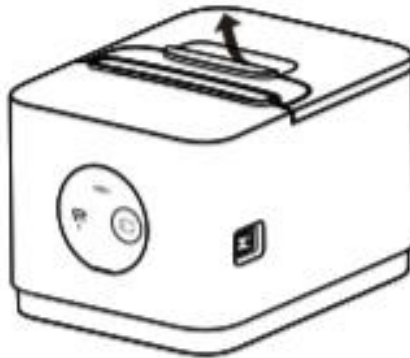

3. Load a paper roll to the paper holder, making sure the roll is placed in the right direction.

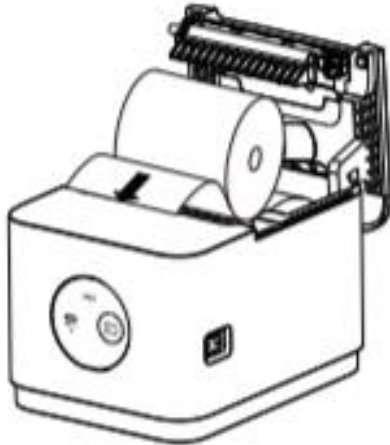

The heat-sensitive side faces outward

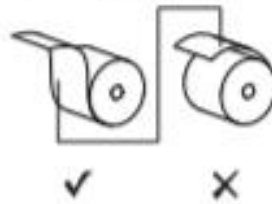

The heat-sensitive side faces inward

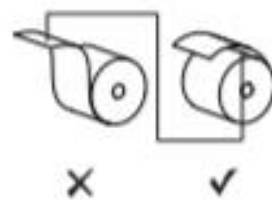

3.Loading the paper roll

4.Pull a section of paper out of the printer and close the cover.

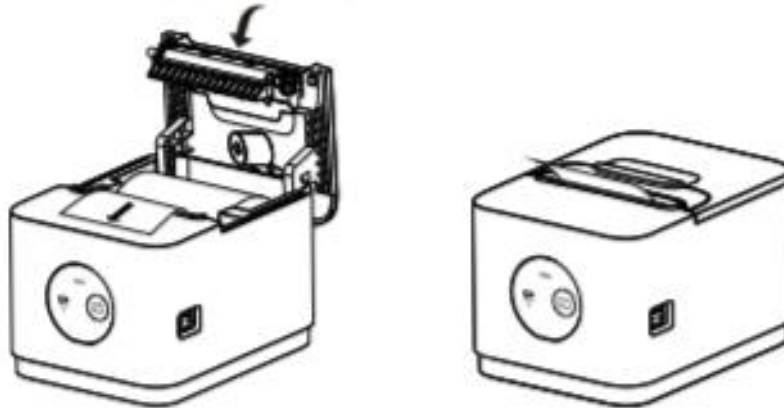

Warm tip: After power on, open and close the paper bin cover, the cutter will automatically remove excess paper.

4.Power Connection

- 1.Make sure the power switch is at the Off position.
- 2.Connect the power adapter to the printer.
- 3.connect the power cable to the power adapter.
- 4.connect the other end of the power cord to a nearby outlet.

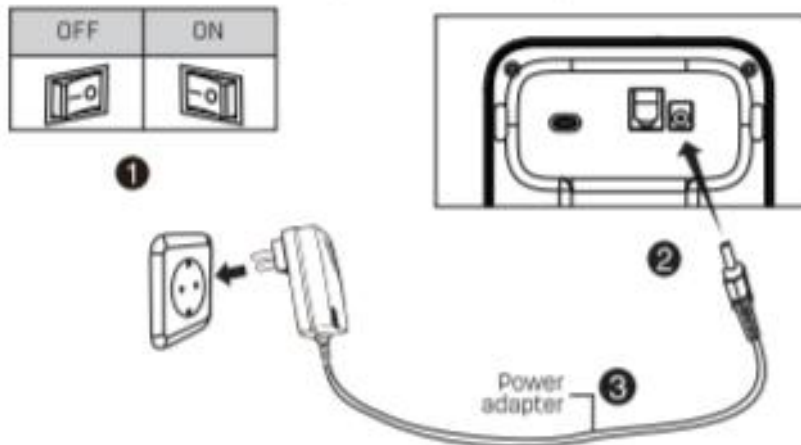

WARRANTY CARD

Thank you for your purchase of our products. The interests of customers who purchase our products will be protected. For any malfunction due to product quality problems, please contact authorized local dealers or service centers with this receipt and the warranty card.

Warranty terms:

1. For product failures occur under normal operating circumstances, free of charge repair and spare parts

replacement service shall be provided by our company within one year commencing from date of purchase.

2. Customers are required to present this warranty card and the original purchase invoice to our company upon request for warranty service. This warranty card shall be valid only after the following form is filled out in details and affixed with official seal of the dealer.

3. No free of charge repair service shall be provided in the event of any of the following circumstances:

(1) Expiration of the warranty period;

(2) Damages caused by improper use, maintenance or storage not in accordance with the requirements of the user manual;

(3) Failure or damage resulting from unauthorized disassembly, repair or modification;

(4) Failure or damage caused by force majeure;

(5) Wear parts or accessories.



This warranty card is being delivered with the product, one card for one product. Please keep this warranty card in proper condition for free warranty service. There is no replacement if lost.

Date of Purchase: _____ Y _____ M _____ D

Product Information	Product Name				Serial Number		
	Product Model Number				Manufacturing Date		
Customer Information	Company Name				Contact		
	Address				Phone		
Sales Information	Dealer Name				Contact		
	Address				Phone		
	Date of Purchase				Invoice No.		
Maintenance Record	Description of Malfunction	Maintenance Results	Customer Signature	Maintenance Technician Signature	Maintenance Date		

 This copy shall be cut along the dotted line and kept by the dealer.

Product Information	Product Name				Serial Number		
	Product Model Number				Manufacturing Date		
Customer Information	Company Name				Contact		
	Address				Phone		
Sales Information	Dealer Name				Contact		
	Address				Phone		
	Date of Purchase				Invoice No.		
Maintenance Record	Description of Malfunction	Maintenance Results	Customer Signature	Maintenance Technician Signature	Maintenance Date		

-  WARNING: Running this device in a residential environment may cause radio interference.
-  WARNING: Has sharp edges, do not touch.
-  WARNING: Hot parts! Touching the parts will burn your fingers, wait half an hour after turning off the power before touching the parts.

<p>CERTIFICATE</p> <p>Inspector: _____</p> <p>Date of Manufacture: _____</p>

DELI GROUP CO., LTD.

Deli Industrial Zone, Ninghai County, Ningbo
City, Zhejiang Province, China Made in China
info@nbdeli.com www.deliao.com



**KEEP FOR
FUTURE USE**

Version: 1.1
Date: 12-2025